



Ultra-High-Resolution CMOS Monochrome Camera CSC12M25BMP19 PRODUCT SPECIFICATION

CONTENTS

Restriction For Use	1
Exemption Clauses	2
Notes on using this product	3
CAUTIONS ON USE	5
1. Overview	6
2. Features	6
3. Configuration	7
4. Option parts	7
5. Specification	8
6. Command Communication Protocol	17
7. Register Map	19
8. Function	21
9. External-view Drawing	25
10. Guarantee	26
11. Repair	26

TOSHIBA TELI CORPORATION

Restriction For Use

- Should the equipment be used in the following conditions or environments, give consideration to safety measures and inform us of such usage:
 1. Use of the equipment in the conditions or environment contrary to those specified, or use outdoors.
 2. Use of the equipment in applications expected to cause potential hazard to people or property, which require special safety measures to be adopted.
- This product can be used under diverse operating conditions. Determination of applicability of equipment or devices concerned shall be determined after analysis or testing as necessary by the designer of such equipment or devices, or personal related to the specifications. Such designer or personal shall assure the performance and safety of the equipment or devices.
- This product is not designed or manufactured to be used for control of equipment directly concerned with human life (*1) or equipment relating to maintenance of public services/functions involving factors of safety (*2). Therefore, the product shall not be used for such applications.

(*1): Equipment directly concerned with human life refer to:

- Medical equipment such as life-support systems, equipment for operating theaters.
- Exhaust control equipment for exhaust gases such as toxic fumes or smoke.
- Equipment mandatory to be installed by various laws and regulations such as the Fire Act or Building Standard Law.
- Equipment related to the above.

(*2): Equipment relating to maintenance of public service/functions involving factors of safety refer to:

- Traffic control systems for air transportation, railways, roads, or marine transportation.
- Equipment for nuclear power generation.
- Equipment related to the above.

Although sufficient check is performed about translation of these specifications, we will apply a Japanese sentence, if a doubt should occur.

Exemption Clauses

- TELI assumes no responsibility or liability for damage arising from fire, earthquake, an act by a third party or other accidents, or intentional or careless error or misuse by the user, or use under abnormal conditions.
- TELI assumes no responsibility or liability for incidental damages (e.g., loss of business profits or interruption of business) arising from use of or inability to use the camera equipment.
- TELI assumes no responsibility or liability in the case damages or losses are caused by failure to observe the information contained in the operation manual and specifications.
- TELI assumes no responsibility or liability in the case damages or losses are caused by use contrary to the instructions in this operation manual and specifications.
- TELI assumes no responsibility or liability in the case damages or losses are caused by malfunction or other problems resulting from use of equipment or software that is not specified.
- TELI assumes no responsibility or liability in the case damages or losses are caused by repair or modification conducted by the customer or any unauthorized third party (such as an unauthorized service representative).
- Expenses we bear on this product shall be limited to the individual price of the product.
- TELI does NOT guarantee the items that are not described in the specification.

Notes on using this product

- Handle carefully

Do not drop the equipment or allow it to be subject to strong impact or vibration, as such action may cause malfunctions. Further, do not damage the connection cable, since this may cause wire breakage.

- Environmental operating conditions

Do not use the product in locations where the ambient temperature or humidity exceeds the specifications.

Otherwise, image quality may be degraded or internal components may be adversely affected. In particular, do not use the product in areas exposed to direct sunlight. Moreover, during shooting under high temperatures, vertical stripes or white spots (noise) may be produced, depending on the subject or camera conditions (such as increased gain). However, such phenomena are not malfunctions.

- Regarding a lens mount

Install a next lens; Dimension of protrusion from flange is equal to or less than 8.1 mm. If a lens does not stand to this condition, it might not be installed to this camera.

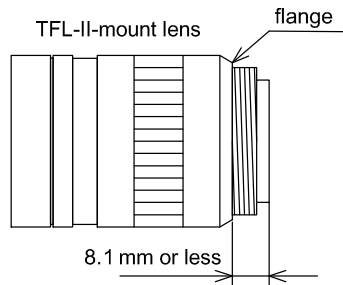

- Check a combination with the lens

Depending on the lens and lighting you use, an image is reflected as a ghost in the imaging area. However, this is not because of a fault of the camera.

In addition, depending on the lens you use, the performance of the camera may not be brought out fully due to deterioration in resolution and brightness in the peripheral area, aberration and others.

Be sure to check a combination with the camera by using the lens and lightning you actually use.

When installing a lens in the camera, make sure carefully that it is not tilted.

In addition, use a mounting screw free from defects and dirt. Otherwise, the camera may be unable to be removed.

Notes on using this product

- Avoid intensive light

Do NOT expose the camera's image-pickup-plane to sunlight or other intense light directly. If the part of CMOS sensor is exposed to spot-intensive light, you might get a picture problem like blooming and/or smear. Under the comparison at the same video output level, the shorter the exposure time setting, the more smear is generated.
- Do not expose the camera's image-pickup-plane to sunlight or other intense light directly.

Its inner CMOS sensor might be damaged.
- Occurrence of moire

If you shoot thin stripe patterns, moire patterns (interference fringes) may appear. This is not a malfunction.
- Occurrence of noise on the screen

If an intense magnetic or electromagnetic field is generated near the camera or connection cable, noise may be generated on the screen. If this occurs, move the camera or the cable.
- Handling of the protective cap

If the camera is not in use, attach the lens cap to the camera to protect the image pickup surface.
- If the equipment is not to be used for a long duration

Turn off power to the camera for safety.
- Maintenance

Turn off power to the equipment and wipe it with a dry cloth.
If it becomes severely contaminated, gently wipe the affected areas with a soft cloth dampened with diluted neutral detergent. Never use alcohol, benzene, thinner, or other chemicals because such chemicals may damage or discolor the paint and indications.
If the image pickup surface becomes dusty, contaminated, or scratched, consult your sales representative.

CAUTIONS ON USE

- When disposing of the camera

Wastes of this product should be separated and discarded in compliance with the various national and local ordinances.

This camera is showing the following symbol to body due to EU environmental regulation (Waste Electrical and Electronic Equipment (WEEE)). However this symbol is applied to only an EU member state.



Phenomena specific to CMOS sensor

- Defective pixels

A CMOS image sensor is composed of photo sensor pixels in a square grid array. Due to the characteristics of CMOS image sensors, over- or under-driving of the pixels results in temporary white or black areas (as if these are noises) appearing on the screen. This phenomenon, which is not a defect is exacerbated under higher temperatures and long exposure times.

- Image shading

The brightness of the upper part of the screen may be different from that of the lower part. Note that this is a characteristic of a CMOS image sensor and is not a fault.

This phenomenon is generated when the shutter speed is fast.

We recommend that the shutter speed of the camera should be slower than 1/100s to reduce the effect by this phenomenon

1. Overview

This CMOS camera is an Ultra-High-resolution monochrome camera employing a 12,580 thousand pixel readout system CMOS sensor.

2. Features

(1) High speed output at Ultra-High-resolution pixel.

The TOSHIBA TELI's proprietary 1.9 type 12,580 thousand pixel Ultra-High-resolution CMOS sensor outputs the entire 12,580 thousand pixels in a speed as high as 25fps. A high amount of information in 320M Byte/Sec. output data rate is obtainable in 8bit mode and 640M Byte/Sec. output data rate is obtainable in 10bit mode.

(2) WOI (Window Of Interest)

WOI (Window Of Interest) of a partial readout function optimum to diversifying high-speed image processing is available.

It supports a variable frame rate to increase the frame rate by reading an arbitrary area by specifying an address in horizontal and vertical directions.

(3) Global shutter

As it employs a global electronic shutter similar to a CCD image sensor, clear images of even fast-moving object are obtainable with less blur.

(4) Random trigger shutter

Photo images can be imported in any timing by inputting external trigger signals.

(5) Camera Link interface

Image output and camera control interfaces employ the camera link standard.

The dual MDR connector supporting Camera Link Medium Configuration outputs the entire 12,580 thousand pixels in a speed as fast as 25fps. As it also supports Camera Link Base Configuration to output the entire 12,580 thousand pixels in a speed as high as 12.5fps by a single one-sided MDR connector, it can support a wide variety of image processors.

(6) Wide dynamic range

A wide dynamic range can be achieved by compressing brightness information of an object by employing a multi-slope multiple storage method (to be implemented).

(7) Binning

Signals can be output in all effective areas in about 43.5fps by reading 2(H)x2(V) pixels as one pixel.

(8) Sub sampling

The frame rate can be increased by skipping effective pixels.

(9) New lens mount TFL-II

TOSHIBA TELI's unique TFL-II mount to take advantage of the resolution of a large high-precision sensor is employed for the lens mount. The TFL-II mount is large and has a flange back as short as 17.5mm to support high performance lenses. The lens attaching part is a M48 screw mount with ϕ 50mm positioning engaging mechanism to support high precision. An F mount lens can also be used via an optional FTAR-2 mount conversion adaptor.

3. Configuration

- (1) Camera body x 1
- (2) Accessory
 - Operation Manual (Japanese) x 1
 - Operation Manual (English) x 1

*Application software is not attached to this camera.

4. Option

- (1) Power cable CPRC3700-**:1m-9m (Manufactured by TOSHIBA TELI)
- (2) Camera Link cable 14B26-SZLB-***-0LC (Manufactured by 3M)
 (Recommended cable length: 5m or less)
- (3) Camera adapter CA130C, CA130C-01 (Manufactured by TOSHIBA TELI)
- (4) Camera mounting kit CPTC12M (Manufactured by TOSHIBA TELI)
- (5) F mount lens adapter FTAR-2 (Manufactured by TOSHIBA TELI)

*NOTE: Contact your dealer / distributor for details of option units.

***Conformity of optional peripherals and EMC regulations**

The adaptability of the safety standard of this camera is guaranteed in the condition of combination with the above-mentioned option parts. The customer must execute the confirmation of a final safety conformance with the machine and the entire device when it combines with parts other than our specification and it is used.

5. Specification

[Electrical specification]

(1)	Imager	CMOS image sensor
	• Number of active pixels	4096 (H) × 3072 (V)
	• pixel size	6 μm (H) × 6 μm (V) (Square-grid array)
	• Scanning area	24.576 mm(H) x 18.432 mm(V)
	• Optical size	Equivalent to 1.9 type
(2)	Scanning system	Progressive
(3)	Aspect ratio	4:3
(4)	Synchronization method	Internal synchronization
(5)	Sensitivity	2000 lx, F5.6, 3000 K
(6)	Minimum object illuminance	30 lx (F2.8, GAIN MAX, reading all pixels, image level 50%)
(7)	Image output	Compliant with Camera Link standard
	• Output mode	Switchable between Base and Medium configuration (Factory setting: Medium configuration)
	• Data	8 / 10 bit switching (Factory default: 8 bit)
	• Readout mode	
	All pixel readout	Approx. 25 fps / 4096(H) × 3072(V)
	Binning	Approx. 43.5 fps / 2048(H) × 1536(V)
	Sub sampling	2x2 : Approx. 50fps / 2048(H) × 1536(V) 4x4 : Approx. 100fps / 1024(H) × 768(V) 8x8 : Approx. 200 fps / 512(H) × 384(V)
	WOI	Depends on the window setting.
(8)	Gain	
	• Digital gain	0 to +18 dB [180step, 1step= Approx. 0.1dB] (Factory default : 0 dB)
(9)	Set-up level	0 to Approx.+13% [528step] (Factory default : Approx.+3.9%...132)
(10)	Dynamic range	Approx. 58 dB (standard)
(11)	Gamma	1.0 (standard)
(12)	Power supply voltage	DC12 V ± 10 % (ripple 50 mV(p-p) or less)
(13)	Power consumption	Approx. 5 W

[Electrical shutter specification]

- | | |
|----------------------------|--|
| (1) Shutter Speed | Shutter OFF or 1/20,000 to 2 sec |
| | The exposure time at shutter OFF is different depending on the reading mode. (Factory default : Shutter OFF) |
| (2) Random Trigger Shutter | ON / OFF switching (Factory default : OFF) |
| • Fixed mode | The exposure time depends on the shutter speed setting |
| • Pulse width mode | The exposure time depends on the pulse width. |
| | Minimum pulse width : 50 μ sec |
| | (Minimum exposure time: 50 μ sec) |

Note: The brightness of the upper part of the screen may be different from that of the lower part. Note that this is a characteristic of a CMOS image sensor and is not a fault. This phenomenon is generated when the shutter speed is fast. We recommend that the shutter speed of the camera should be slower than 1/100s to reduce the effect by this phenomenon.

[Internal sync signal specification]

- | | |
|-----------------------|----------------------------|
| (1) Driving frequency | |
| • Output mode | *Shutter OFF |
| All pixel readout | Horizontal : Approx.75 kHz |
| | Vertical : Approx.25 Hz |
| Binning | Horizontal : Approx.67 kHz |
| | Vertical : Approx.43.5 Hz |
| WOI | By window setting |

[Input signal specification]

- | | |
|----------------------------------|---|
| (1) TRIG | Camera Link I/F and DC IN connector input |
| • Signal level (DC IN connector) | TTL level |
| • Polarity | Positive/Negative switching (Factory default: Negative) |
| • Pulse width | 50 μ sec or more |

[Output signal specification]

None

[Mechanical spec]

- | | |
|--|---|
| (1) Lens mount | TOSHIBA TELI's unique TFL-II mount |
| ▪ Mount screw | M48mm P=0.75 |
| ▪ Positioning engagement part | Φ50mm H7 |
| ▪ Flange back | 17.5 mm |
| (2) Dimensions | 75 mm (W) × 75 mm (H) × 69.5 mm (D)
(Not including protrusion) |
| (3) Weight | Approx.450 g |
| (4) Camera body grounding: insulation status | Conductive between circuit GND and camera body |

[Operating ambient conditions]

- | | |
|---------------------------|---|
| (1) Performance assurance | Temperature : 0 to +40□ |
| | Humidity : 10% to 90% (No dew formation) |
| (2) Operation guaranteed | Temperature : -5 to +50□ |
| | Humidity : 10% to 90% (No dew formation) |
| (3) Storage | Temperature : -20 to +60□ |
| | Humidity : 90% or less (No dew formation) |

[Typical ambient conditions]

Spectral Sensitivity Specification for CSC12M25BMP19

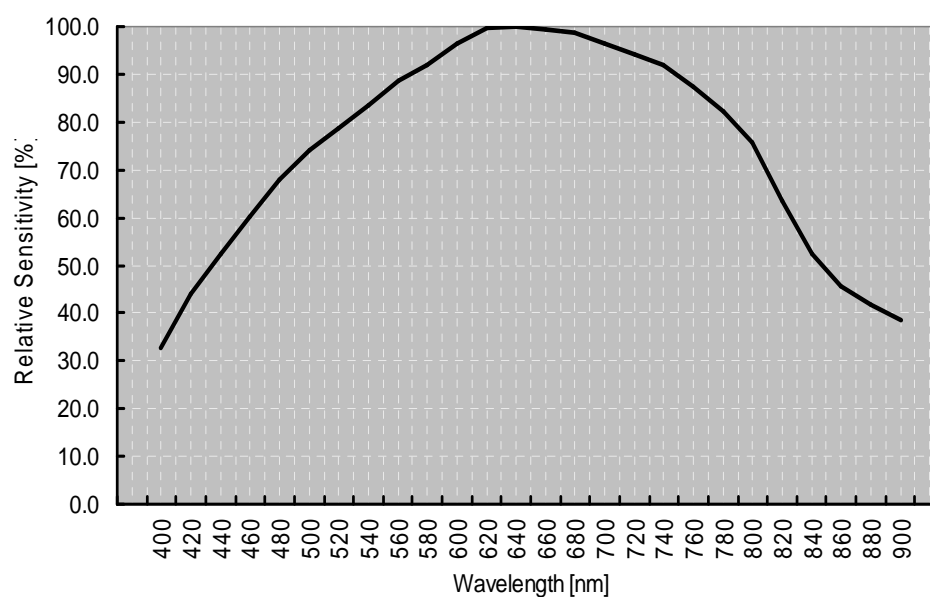

(*The lens characteristics and light source characteristics are not reflected in table.)

[Various safety standards]

- (1) Electro-Magnetic Compatibility
 - EMI(Electro-Magnetic Interference) EN61000-6-4 / 2001 to be acquired
 - EMS(Electro-Magnetic Susceptibility) EN61000-6-2 / 2001 to be acquired
- (2) FCC: FCC Part 15 Subpart B class A to be acquired

[Communication specification]

- (1) Communication speed 9600 / 19200 / 38400 / 57600 bps switching
- (2) Start bit 1bit
- (3) Data bit 8bit
- (4) Stop bit 1bit
- (5) Parity None
- (6) Handshake None

[Connector pin assignment]

(1) Video output/controlling (Camera Link Medium Configuration) CAMERA LINK1 • 2

• Connector type: MDR 26-PIN connector 10226-2210PE (Manufactured by 3M)

●Connector name : CAMERALINK1

Pin No.	I/O	Signal name	Pin No.	I/O	Signal name
1	-	GND	14	-	GND
2	O	X0-	15	O	X0+
3	O	X1-	16	O	X1+
4	O	X2-	17	O	X2+
5	O	X CLK OUT-	18	O	X CLK OUT+
6	O	X3-	19	O	X3+
7	I	Ser TC (RxD) +	20	I	Ser TC (RxD) -
8	O	Ser TFG (TxD) -	21	O	Ser TFG (TxD) +
9	I	CC1 (TRIG) -	22	I	CC1 (TRIG) +
10	I	CC2 (MULTI) +	23	I	CC2 (MULTI) -
11	I	CC3-	24	I	CC3+
12	I	CC4+	25	I	CC4-
13	-	GND	26	-	GND

●Connector name : CAMERALINK2

Pin No.	I/O	Signal name	Pin No.	I/O	Signal name
1	-	GND	14	-	GND
2	O	Y0-	15	O	Y0+
3	O	Y1-	16	O	Y1+
4	O	Y2-	17	O	Y2+
5	O	Y CLK OUT-	18	O	Y CLK OUT+
6	O	Y3-	19	O	Y3+
7	-	100Ω terminated(20)	20	-	100Ω terminated(7)
8	-	N.C.	21	-	N.C.
9	-	N.C.	22	-	N.C.
10	-	N.C.	23	-	N.C.
11	-	N.C.	24	-	N.C.
12	-	N.C.	25	-	N.C.
13	-	GND	26	-	GND

(2) Power supply connector DC IN

- Connector (camera side) : HR10A-10R-12PB(71) (HIROSE ELECTRIC)
- Compatible plug (cable side): Equivalent to HR10A-10P-12S(73) (HIROSE ELECTRIC) or equivalent

Pin No.	I/O	Signal name
1	-	GND
2	I	+12V
3	-	GND
4	-	N.C.
5	-	GND
6	-	N.C.
7	-	N.C.
8	-	GND
9	-	N.C.
10	-	N.C.
11	I	TRIG
12	-	GND

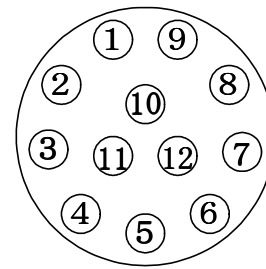

Rearview

[Dip switch setting]

Various settings are available with the dip switch on the back.

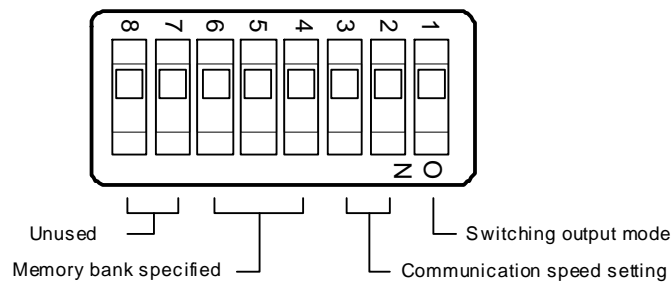

“*” is Factory default

(1) Output mode switching

Switch between Medium Configuration and Base Configuration.

The power of the camera needs be turned on again to switch modes.

SW1	Output mode
OFF	* Medium Configuration
ON	Base Configuration

(3) Baud rate setting

The speed of the serial communication can be set by the camera link.

The power of the camera needs be turned on again to switch modes.

SW2	SW3	Baud rate
OFF	OFF	* 9600 bps
ON	OFF	19200 bps
OFF	ON	38400 bps
ON	ON	57600 bps

(3) Specifying a memory bank before starting

Specify a memory bank to be referenced before turning on the power of the camera for SW4 through SW6. The power of the camera needs be turned on again to switch modes.

SW4	SW5	SW6	Memory bank
OFF	OFF	OFF	* Bank 0
ON	OFF	OFF	Bank 1
OFF	ON	OFF	Bank 2
ON	ON	OFF	Bank 3
OFF	OFF	ON	Bank 4
ON	OFF	ON	Bank 5
OFF	ON	ON	Bank 6
ON	ON	ON	Bank 7

SW7 and SW8 are not used. (Fixed to OFF)

[Timing Chart]

(1) Horizontal Timing

* For Medium configuration Figures in parentheses are for Base configuration

1) Reading all pixels

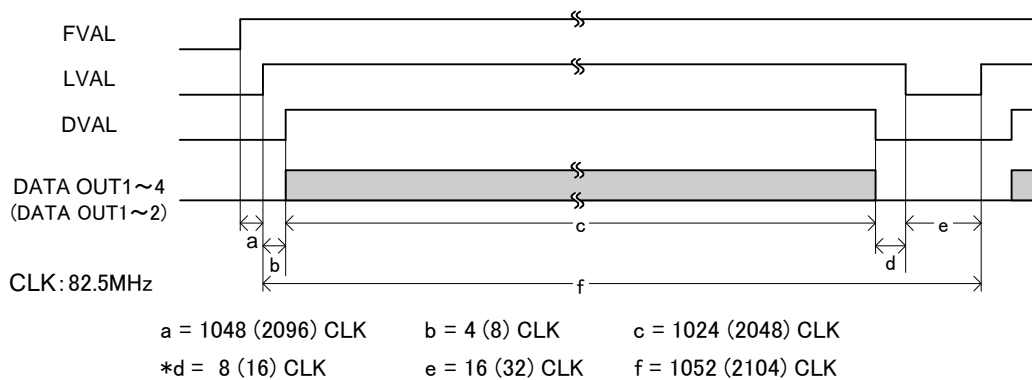

2) CLK rate

•Medium Configuration

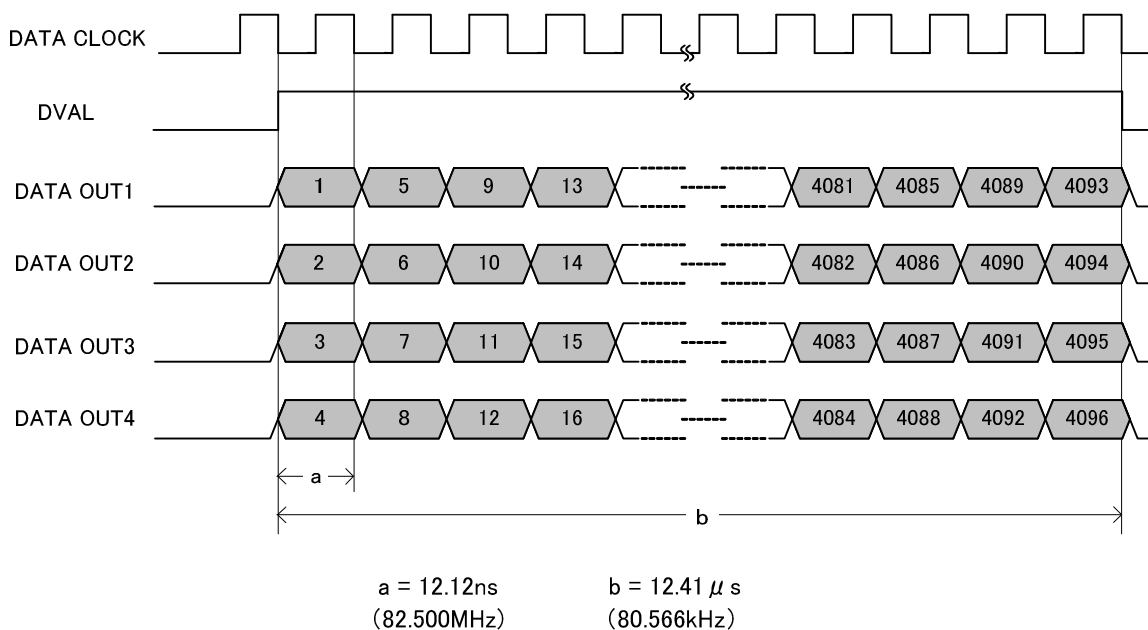

●Base Configuration

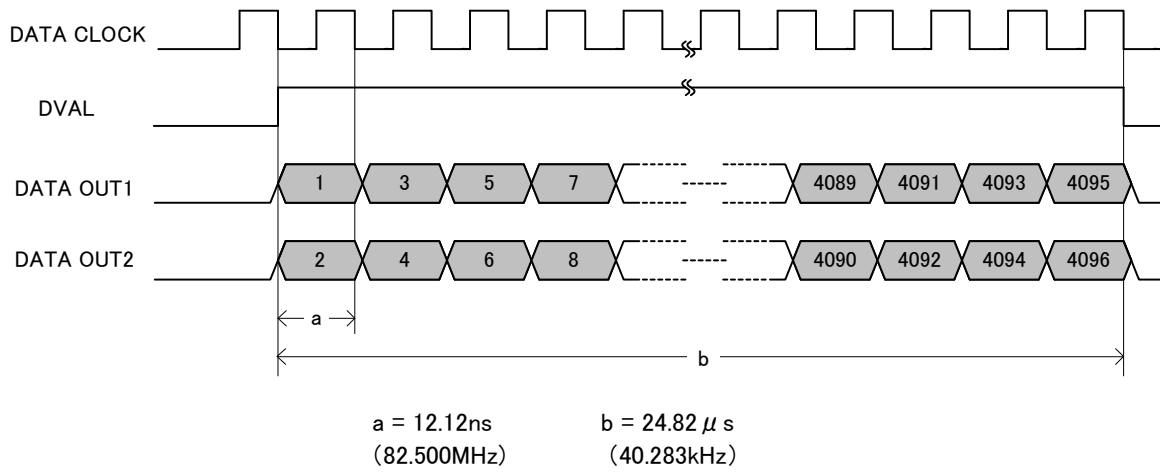

(2) Vertical Timing

*For Medium configuration Figures in parentheses are for Base configuration

1) All pixel readout

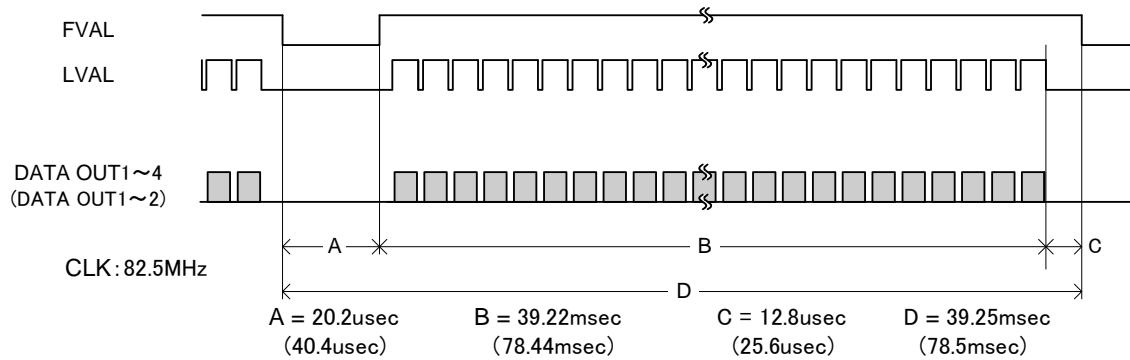

Note: The frame rate changes according to the shutter speed when the shutter is ON.
(The period "A" in the chart indicates the period of the shutter speed.)

6. Command Communication Protocol

The command communication protocol is the TELL standard method (method in which parameters are set in the registers in the camera).

In command send/receive operation, hexadecimal address and data are converted to ASCII data.

All ASCII alphabetic characters used are uppercase characters.

(1) Write to a register

To write data in a register, send a command, as follows. (Address' max-length is 2 bytes, and Data's max-length is 8 bytes)

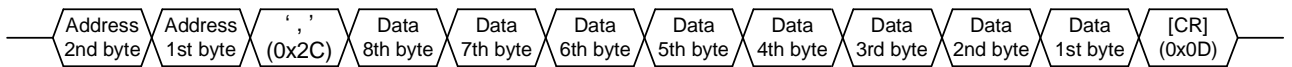

For example, to write data 0x38 to address 0x76, send a command, as follows:

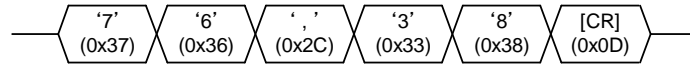

The camera responds to the write command with No Error (ACK) or Error (NAK), as follows:

No Error (ACK):

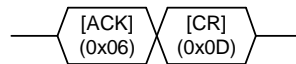

Error (NAK):

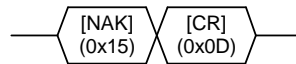

*Because two kinds of data is needed for the setting about the Partial Scan, the register writing for "Set value application" is separately needed.

(2) Reading the register

To read data from a register, send ' , (comma)', 'R', 'Q' and [CR] code following the address.

For example, to read data in address 0x91, send a command, as follows:

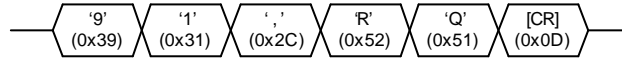

The camera responds to the read request, as follows (Data's max-length is 8 bytes):

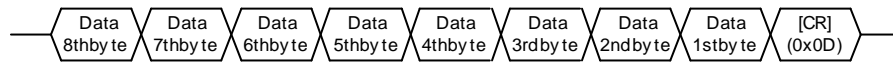

Actually, the camera responds to the read request as minimum data length: For example, to read data 0x10 to address 0x91, the camera responds as follows:

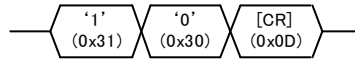

7. Register Map

The following accesses are available via the camera link serial interface.

Address	Access	CMOS Monochrome Camera CSC12M25BMP19		
0x00	R. O.	Manufacturer(Maker) name ASCII format	Manufacturer(Maker) name TOSHIBA TELI	Access R/W : Read/Write possible R. O. : Read Only W. O. : Write Only N. A. : Not Available
0x0F	R. O.	Model name ASCII format	Model name CSC12M25BMP19	
0x2F	R. O.	Serial number ASCII format	Serial number xxxxxxx	
0x30	R. O.	Firmware version ASCII format	Firmware version e.g. 01.01.01	
0x3F	R. O.	FPGA1 version ASCII format	FPGA1 version e.g. 01.01.01	
0x40	R. O.	FPGA2 version ASCII format	FPGA2 version e.g. 01.01.01	
0x47	R. O.	CPLD1 version ASCII format	CPLD1 version e.g. 01.01.01	
0x48	R. O.	Register map version ASCII format	Register map version e.g. 01.01.01	
0x4F	R. O.	Reserved		
0x50	R. O.	Reserved		
0x57	R. O.	Reserved		
0x58	R. O.	Reserved		
0x5F	R. O.	Reserved		
0x60	R. O.	Reserved		
0x67	R. O.	Reserved		
0x68	N. A.	Reserved		
0x69	R. O.	Status	Status Store the status after performing camera control.	Extended status Store detail information corresponding to the status.
0x6A	R. O.	Extended status		
0x6B	N. A.	Reserved		
0x6C	R. O.	Check memory bank	Check memory bank The bit is set according to the saved setting (memory bank number 1).	
0x6D	W. O.	Save memory	Save memory Write memory bank number (1-8). Save memory to the specified number.	
0x6E	R/W	Call memory	Call memory Write memory bank number (0). -> Call default setting. Write memory bank number (1-8). -> Call a setting from the specified number. Read registers. -> Check the memory number used (Use 0 if no memory has been called).	
0x6F	W. O.	Initialize memory		Initialize memory Write memory bank number (1-8). Initialize the specified number.
0x70	R/W	Setup		Setup 0(0LSB) - 528(132LSB@10bit, 33LSB@8bit) Default setting: 264(66LSB@10bit, 16LSB@8bit)
0x72	N. A.	Reserved		Gain 0(0dB) - 180(18dB) Default setting: 0(0dB)
0x75	N. A.	Reserved		
0x76	R/W	Gain		
0x77	N. A.	Reserved		
0x7F	N. A.	Reserved		
0x80	N. A.	Reserved		
0x82	N. A.	Reserved		
0x84	N. A.	Reserved		
0x86	R/W	Output control	Output control 0(OFF) / 1(ON) Default setting: 1(ON)	
0x87	R/W	Number of output bits	Number of output bits 8(8bit) / 10(10bit) Default setting: 8(8bit)	
0x88	N. A.	Reserved		
0x89	N. A.	Reserved		
0x8A	N. A.	Reserved		
0x8B	R/W	Defective pixel correction	Defective pixel correction 0(OFF) / 1(ON) Default setting: 1(ON) Note that it supports only normal scan and WOI scan.	
0x8C	N. A.	Reserved		
0x8D	N. A.	Reserved		
0x8E	N. A.	Reserved		
0x8F	N. A.	Reserved		

Address	Access	CMOS Monochrome Camera CSC12M25BMP19	
0x90	R/W	Scan mode	Scan mode 0(Normal)/1(WOI)/2(Binning)/3(Subsampling) Default setting:0(Normal)
0x91	R/W	Shutter mode	
0x92	R/W	Random trigger mode	
0x93	R/W	Trigger polarity	Shutter mode 0(Normal shutter OFF)/1(Normal shutter)/2(Random trigger shutter) Default setting:0(Normal shutter OFF)
0x94	R/W	Subsampling	
0x95	N. A.	Reserved	
0x9F	N. A.	Reserved	
0xA0	R/W	Shutter speed denominator	Random trigger mode 0(FIX mode)/1(Pulse mode) Default setting:0(FIX mode)
0xA2	N. A.	Reserved	
0xA3	N. A.	Reserved	Trigger polarity 0(Negative polarity)/1(Positive polarity) Default setting:0(Negative polarity)
0xA4	R/W	Shutter speed numerator	
0xA5	N. A.	Reserved	Subsampling 2(x2) / 4(x4) / 8(x8) Default setting:2(x2)
0xBF	N. A.	Reserved	
0xC0	W. O.	WOI update	Shutter speed denominator 1 - 20000 Default setting:25(1/25s)
0xC1	R/W	WOI area number	
0xC2	R/W	WOI horizontal start coordinate	Shutter speed numerator 1 - 255 Default setting:1(1/25s)
0xC4	R/W	WOI vertical start coordinate	
0xC6	R/W	WOI horizontal width	Shutter speed 1/20000s - 2s
0xC8	R/W	WOI vertical height	
0xCA	N. A.	Reserved	WOI update 0x01 write -> Set WOI information to the area specified by the WOI area number register.
0xCB	R/W	Save/call WOI bank	
0xCC	R/W	WOI area effective	WOI area number 0 - 27 Default setting:0 Select the area to be reflected for WOI update.
0xD0	N. A.	Reserved	
0xD1	N. A.	Reserved	WOI horizontal start coordinate 0 - 4080 (Only multiples of 4 to support 4 tap output) Default setting:0
0xD2	N. A.	Reserved	
0xD3	N. A.	Reserved	WOI vertical start coordinate 0 - 3070 Default setting:0
0xD4	N. A.	Reserved	
0xD5	N. A.	Reserved	WOI horizontal width 16 - 4096 (Only multiples of 4 to support 4 tap output) Default setting:4096
0xD6	N. A.	Reserved	
0xD7	N. A.	Reserved	WOI vertical height 2 - 3072 Default setting:3072
0xD8	R/W	Specify user area/address	
0xDA	R/W	Specify user area/data	Save/call WOI bank 0x00 - 0x08, 0x81 - 0x88 Default setting:0 Save or call WOI related registers.
0xDB	W. O.	Erase user area	
0xDC	R/W	Number of bytes to read user area	WOI area effective 0x00000001 - 0x0FFFFFFF Default setting:0x00000001 Enable/disable the area-1 by bit 0, the area 2 by bit 1 . . . and the area 28 by bit 27. Note that disabling all area cannot be accepted.
0xDD	N. A.	Reserved	
0xDE	N. A.	Reserved	Specify user area/address 0x0000 - 0x07FF (2kバイト) Set the address of a user area to write or read data. The value is set to the register specified by the data when the address is set to this register.
0xDF	N. A.	Reserved	
0xE0	N. A.	Reserved	Specify user area/data Write or read data to/from the address specified by the user area/data-specified register. When data is set to this register, data is written to the address specified by the address-specified register. The address to which nothing has been written is initialized by "0x00" (EEPROM).
0xE1	R/W	Multi slope	
0xE2	N. A.	Reserved	Erase user area 0x01 write -> Erase the user area
0xFF	N. A.	Reserved	
			Number of bytes to read user area When the camera reads data, it reads specified bytes of data and outputs it at the same time. The data can be saved in a memory bank.
			Multi slope 0(OFF)/1(Mode-1)/2(Mode-2)/3(Mode-3)/4(Mode-4) Default setting:0(OFF)

Access
R/W : Read/Write possible
R. O. : Read Only
W. O. : Write Only
N. A. : Not Available

8. Function

8.1. Reading mode

The image output is output from the camera link connector, and can take the output image by Frame grabber board. The frame rate and the resolution of the output image that this camera corresponds are as follows. (At shutter OFF.)

Output mode	設定	Frame rate	resolution
All pixel readout		Approx.25 fps	4096 (H) × 3072 (V)
Binning		Approx.43.5 fps	2048 (H) × 1536 (V)
Sub sampling	2 x 2	Approx. 50 fps	2048 (H) × 1536 (V)
	4 x 4	Approx. 100 fps	1024 (H) × 768 (V)
	8 x 8	Approx. 200 fps	512 (H) × 384 (V)
WOI		Depends on the window setting	

8.1.1. All pixel readout

The camera reads all pixels (4096(H) × 3072(V) pixels) in about 25 fps.

8.1.2. Binning

The camera reads all effective areas in about 43.5fps by binning (2x2) for all pixels (4096(H) × 3072(V) pixels). As it reads adjacent 4 pixels as one pixel, the resolution reduces. However, as the pixel noise is averaged, it can output lower noise than that is produced when it reads all pixels.

Complex operation with WOI and sub sampling is not available.

8.1.3. Sub sampling

It reads all effective areas in high speed by scanning in pixel skipping.

Complex operation with binning and WOI is not available.

8.1.4. WOI

Only arbitrary area can be read. Areas can be read in high speed by skipping unwanted areas.

Complex operation with binning and sub sampling is not available.

8.2. Random trigger shutter

Images can be taken and imported at arbitrary timing by inputting an external trigger signal in a random trigger shutter mode.

- External trigger signals can be input from either the camera link I/F CC1 or the DC IN connector. However, signals cannot be input at the same time. Fix an unused input to Low.
- It starts exposure at a rising trigger edge when the polarity is set to positive polarity while it starts exposure at a negative-going trigger edge when the polarity is set to negative polarity.
- Random trigger shutter operates in either the fixed mode and the pulse width mode and has different ways to determine the exposure time depending on the mode.
- Film cannot be exposed during reading images using the random trigger shutter. If inputting triggers is to be continued, input them after finishing image output of the camera.

8.2.1. Fix mode

- The exposure time is determined by the set value of the shutter speed.

*Example of timing charts to expose all pixels

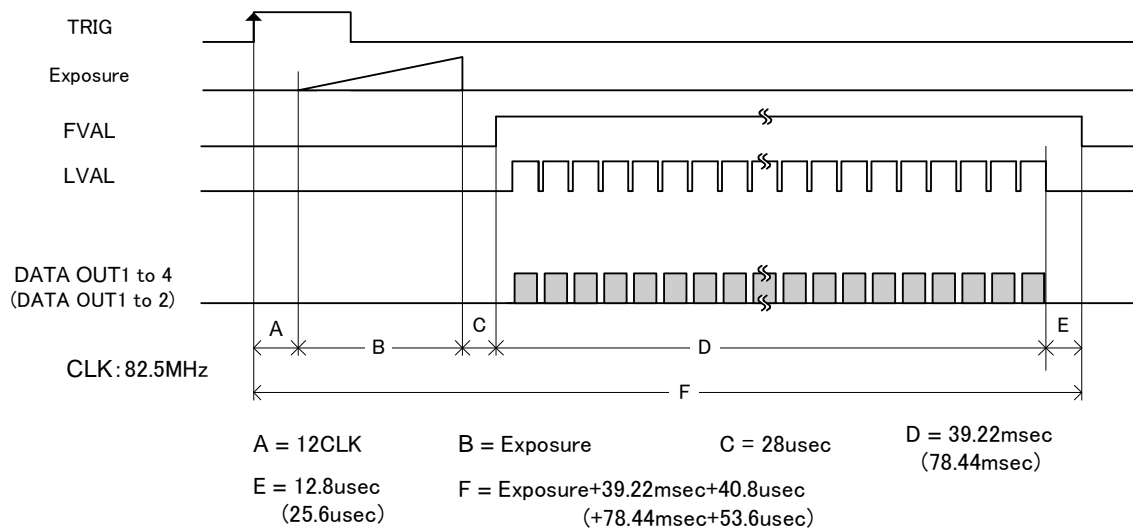

8.2.2. Pulse width mode

- The exposure time is determined by the pulse width (exposure time = pulse width + 2CLK).
- The pulse width should be more than 50 μsec.

*Example of timing charts to expose all pixels

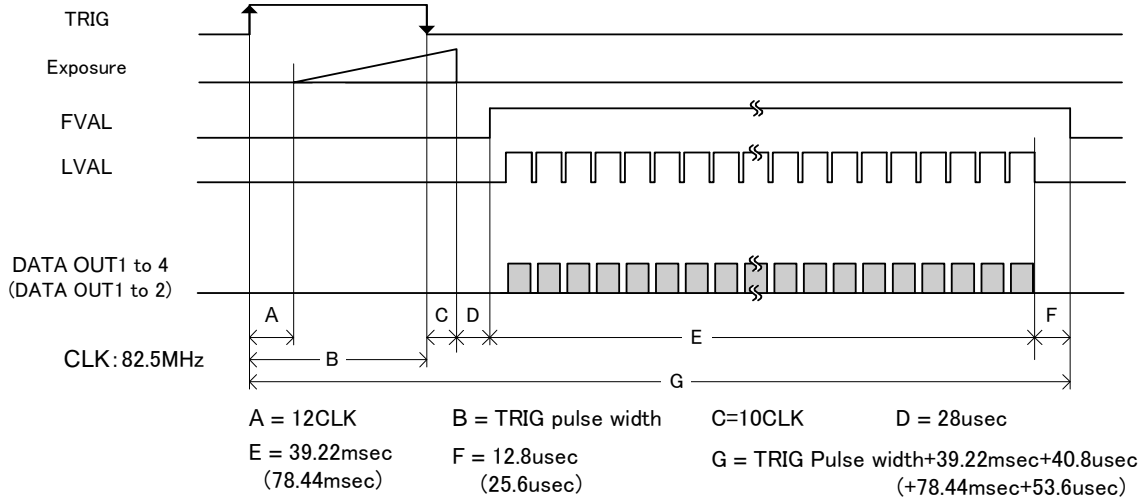

8.3. WOI (Window Of Interest)

Only arbitrary areas can be read by specifying an address in horizontal and vertical directions.

Area setting has the following conditions.

- Number of windows: 1 to 28
- Setting position:
 - H: Integral multiple of 4 columns
 - V: Integral multiple of one row
- Window size:
 - H: Integral multiple of 4 columns (minimum size: 16)
 - V: Integral multiple of one row (minimum size: 2)
- Overlapping of windows: Possible
- Others
 - (1)Frame rate: There is no proportional relation between the window area and the frame rate.
 - (2)Set values of the coordinate and the size: Set the coordinate and the size to fit the effective pixel area. Values cannot set beyond the effective pixel area.
 - (3)Complex operation: Complex operation with binning and sub sampling is not available.
 - (4)Memory: WOI setting can be saved in memory banks 1- 8.

8.3.1 Image output for WOI

Images are outputted per line. Therefore, when multiple windows are set on the same line, images of multiple windows are included in the image output of the line.

(1) When multiple windows are set on the same line

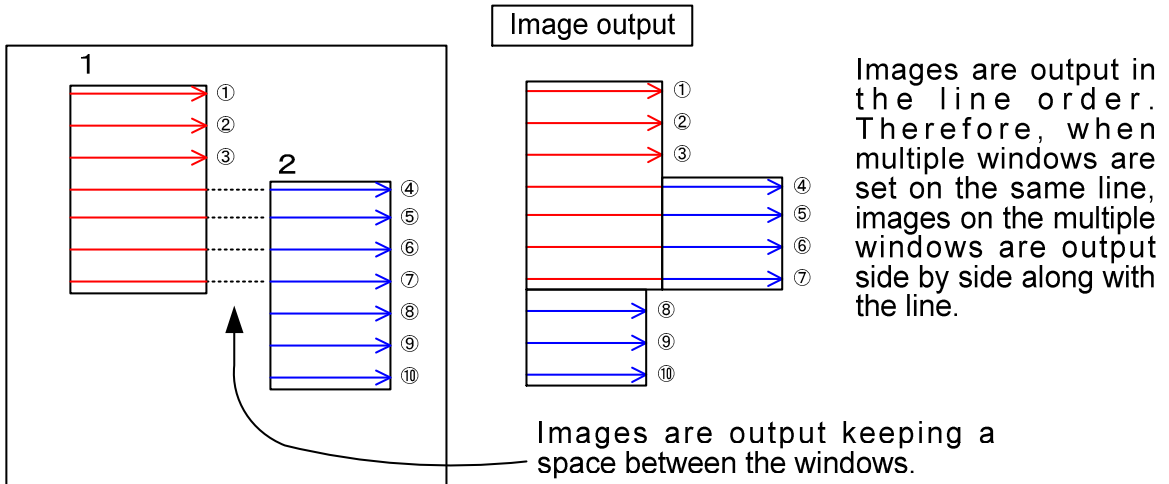

(2) When multiple windows overlap

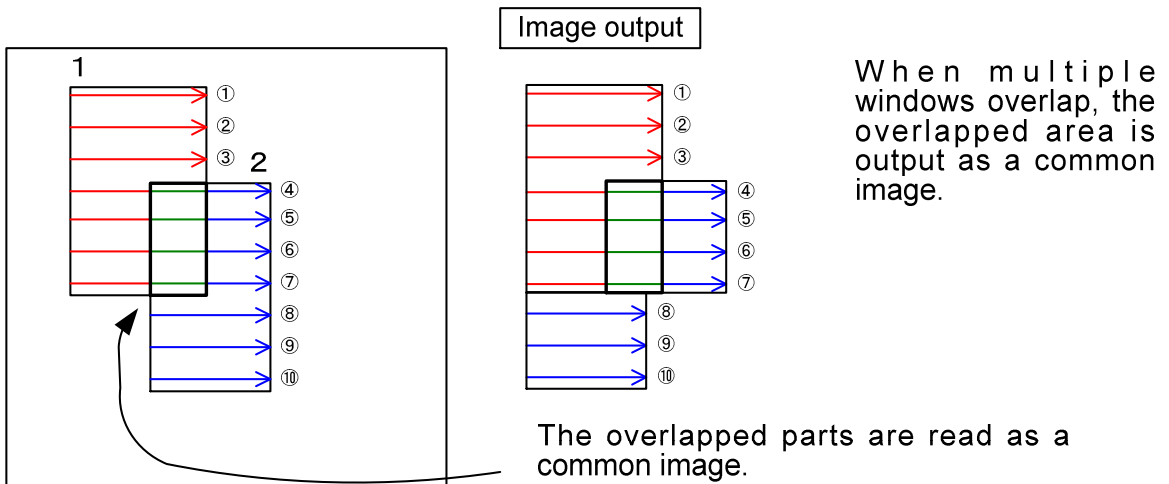

8.4 Multi-slope (to be implemented)

An apparently wide dynamic range is obtainable through exposure up to four times.

Note that the tone may not be correctly represented for the point where the slope switches.

Fixed pattern noise may increase depending on the setting.

9. External-view Drawing

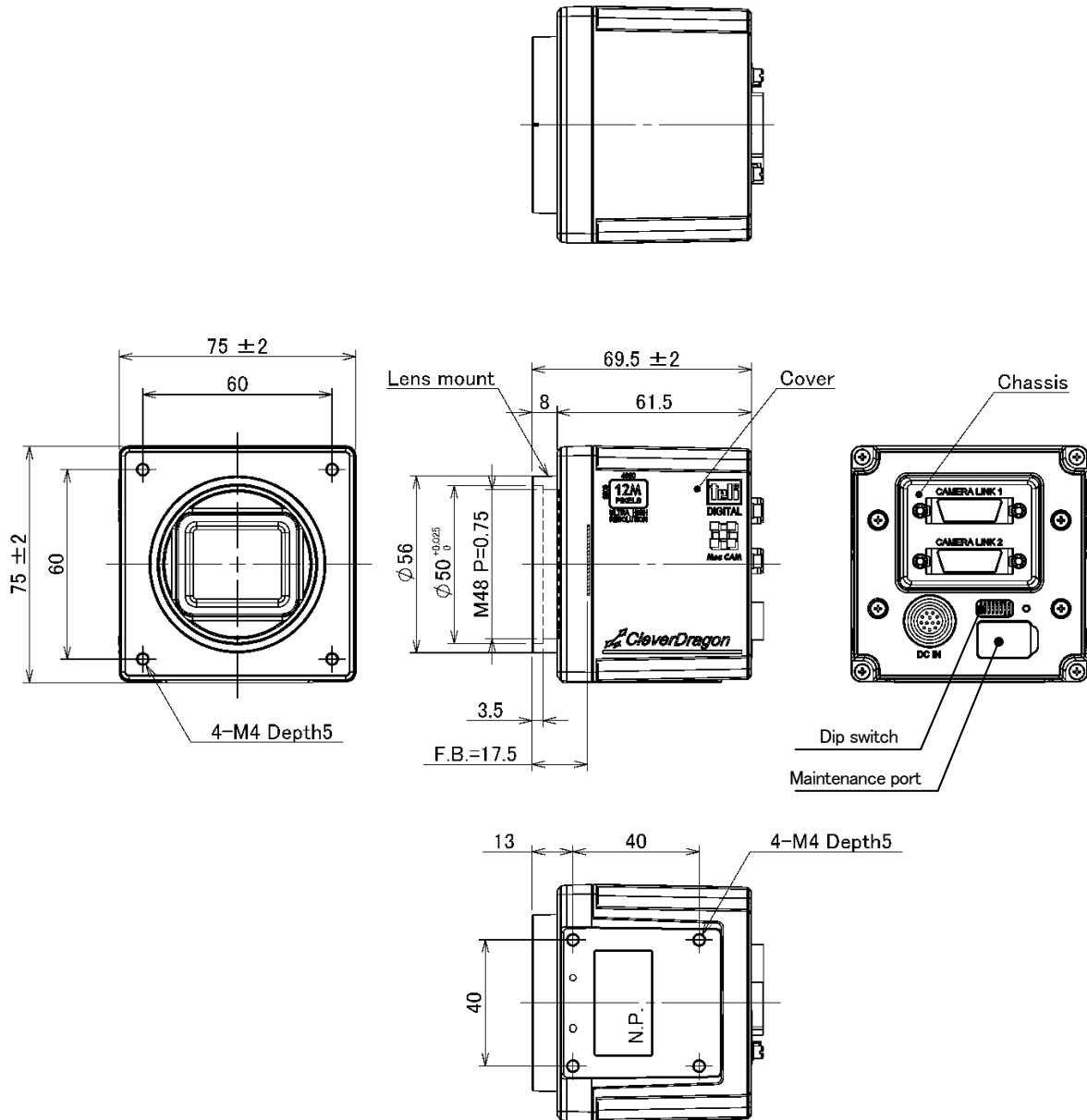

Design specification

Material

Lens mount, Cover : Aluminum die cast

Chassis : Cold rolled steel

Processing

Lens mount, Cover : Cation-resistant aluminum alloy

Chassis : Nickel plating

10. Guarantee

The term of a guarantee is one year after the product delivery.

If by any chance trouble by responsibility of our company occurs before an above period, TELI repairs it free of charge.

- During terms of a guarantee, when the trouble cause is the case of below, TELI charges the repair costs.

- (1) Troubles and the damages that causes by misuse, unsuitable repair or remodeling.
- (2) Distribution hazards like drops and vibrations after purchase. Troubles and damages by transportation.
- (3) Troubles and damages by fire, natural calamity (earthquake, storm and flood damage, thunderbolt), damages from salty breeze, gas harm, abnormal voltage.

11. Repair

Condition for repair

Basically, has to return it to our company when the user requests us to repair product.

Beside that, customer should pay these expenses (travel expenses, camera disassembly technology costs) of both customer and end user. Also customer should pay in themselves costs for return camera to us.

The period of repairing product

- (1) Repair free of charge ... Refer to Clause 8.
- (2) Charged repair Basically, repair period is 7 years after the last production end of products.



TOSHIBA TELI CORPORATION

Head Office: 7-1, 4 chome, Asahigaoka, Hino-shi, Tokyo, 191-0065, Japan

(Overseas Sales Department)

Phone: +81-42-589-8771 Fax: +81-42-589-8774

URL: <http://www.toshiba-teli.co.jp>

The design and specification is subject to change without notice.

Distributor